

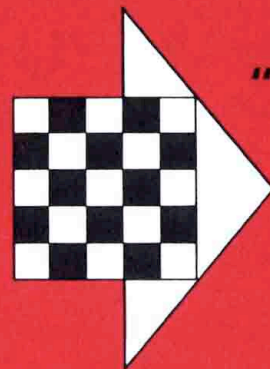

**BOSS
429**



**THE
"TAKE CHARGE"
MUSTANG
FROM**

FORD



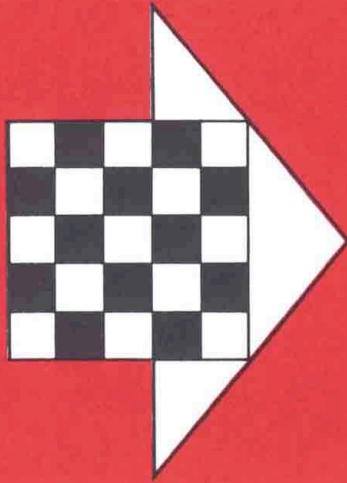

BOSS 429

A hot new entry into Ford's "Performance Corner" . . . the new BOSS 429 Mustang SportsRoof model is sure to turn your dealership into the "pit stop" of activity in your community.

All is "GO" in performance with the "BOSS" starting with its all-new "429-CID Cobra Jet HO" ram-air engine right down to the chrome-plated "Magnum 500" wheels. And, sporting a weight distribution percentage of 56/44, the BOSS 429 includes a functional

front spoiler to provide even better traction in handling.

The exterior design of the "BOSS" is unmistakably Mustang . . . changed only by its massive functional hood scoop and spoiler and a slight modification to the fender wheel lips to accommodate the extra inch of tread and the F60 x 15 tires. Colors available are Raven Black, Royal Maroon, Candyapple Red, Wimbledon White, Blue and Black Jade.

The carpeted all-black interior,



quieted by the special Mach I sound insulation package, features Ford's "Comfortweave" knitted vinyl on high-back bucket seats.

STANDARD OR MANDATORY EQUIPMENT

The impressive BOSS 429 equipment listing includes: • Powerful 429-CID, 375 horsepower Cobra Jet HO V-8 engine with a driver-controlled ram-air intake, hemi-cylinder heads, full-flow exhaust manifolds, unique high rise intake manifold, cast aluminum rocker covers, a forged steel crank-

shaft and a Holley 735-cfm 4-barrel carburetor • High-capacity engine oil cooler • 65-Ampere alternator • 85-Ampere hour trunk-mounted battery • Power steering with special power steering oil cooler • 4-Speed close-ratio manual transmission • Power front disc brakes • 3.91:1 Rear axle with "Traction-Lok" differential • Special suspension system with ultra-heavy-duty performance front and rear springs and shock absorbers, extra-heavy-duty competition front and rear stabilizer

bars, and a staggered rear shock absorber arrangement with one shock ahead of and the other behind the rear axle • Front Spoiler • F60 x 15 Wide-oval fiberglass belted tires with raised brand name white letters • Chrome-plated 15 x 7 "Magnum 500" steel wheels • Tachometer • Interior decor group • Console • High-back bucket seats with "Comfortweave" knitted-vinyl trim • Dual racing mirrors • Visibility group • Deluxe seat belts • Long-wearing nylon carpeting.

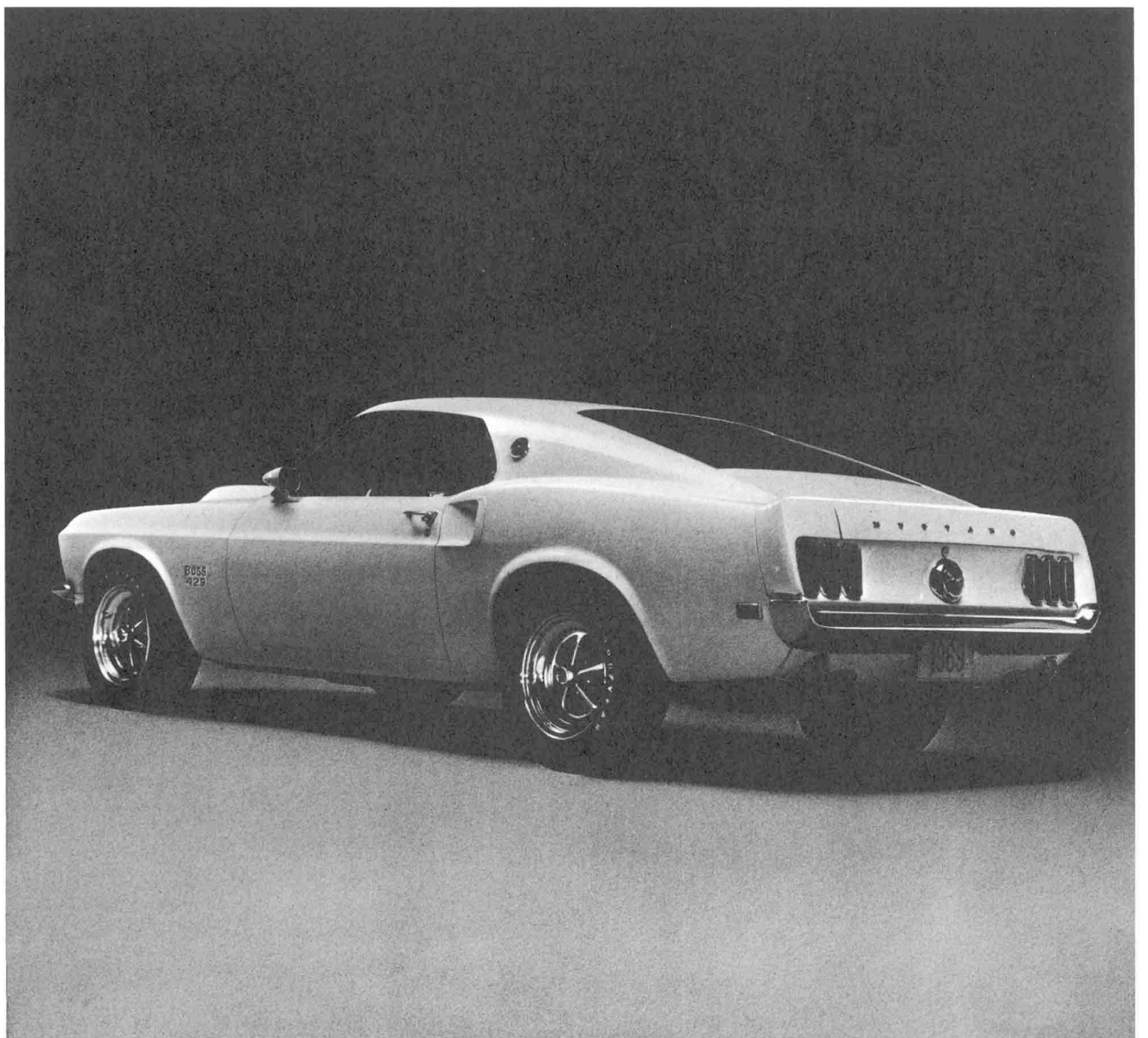

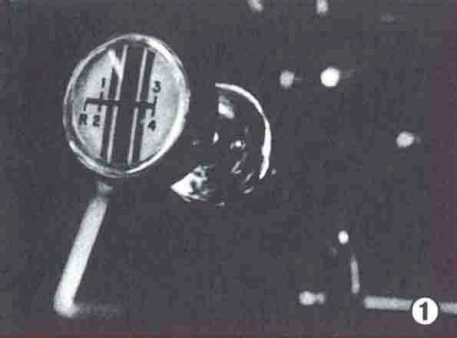

1

1. Four-Speed Manual Transmission
2. 375 HP "429-CID Cobra Jet HO" V-8
3. Competition-Type Suspension with Staggered Shock Arrangement
4. Daytona-Type "Traction-Lok" Differential
5. Driver-Controlled Ram Air Induction System

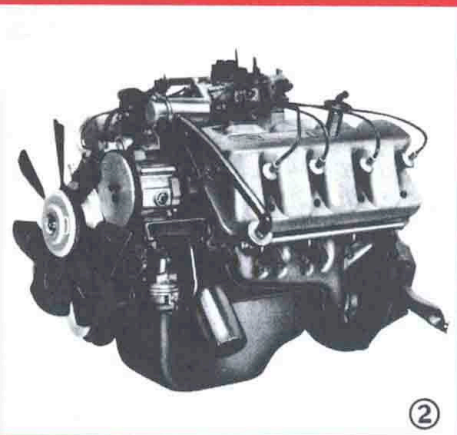

2

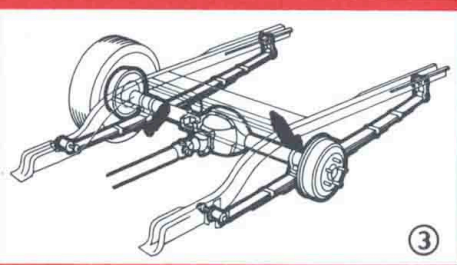

3

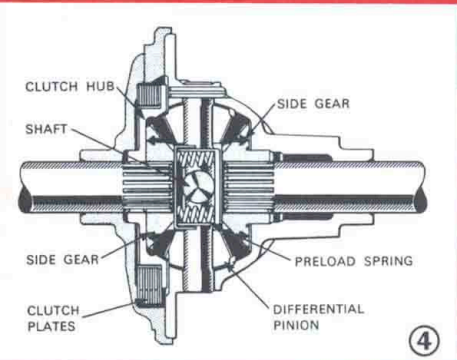

4

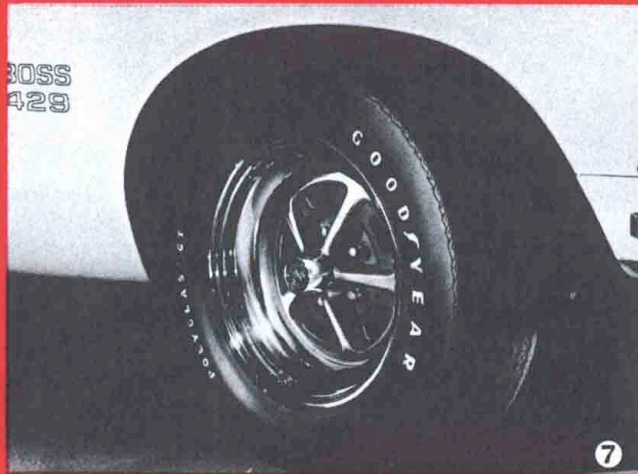

7

6. Specially-Engineered Front Spoiler

7. "Magnum 500" Chrome Steel Wheels and F60 x 15 Wide-Oval Fiberglass Belted Tires

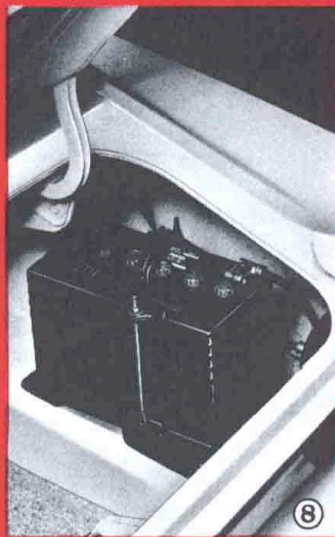

8

8. Unique Trunk-Mounted Battery

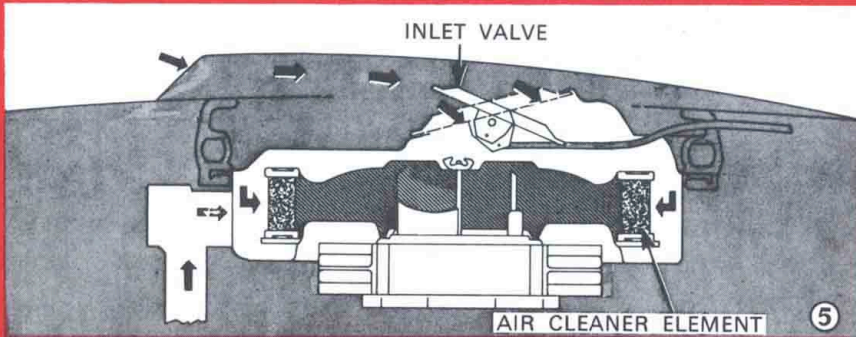

5



6

**BOSS
429**

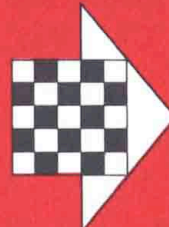

DIMENSIONS

Wheelbase.....	108
Tread Front.....	59.3
Tread Rear.....	58.5
Overall Height.....	51.2
Overall Length.....	187.14
Overall Width.....	71.9

SPECIFICATIONS

Curb Weight (lbs.).....	3716
Tire Size.....	F60 x 15
Brakes.....	Power Front Disc, Rear Drum
Engine Type.....	429 cu. in. OHV V-8
Compression Ratio.....	10.5:1
BHP.....	375
Torque @ 3400 RPM (lbs./ft.).....	410
Weight Distribution %.....	56/44
Construction.....	Steel, Platform Chassis

ENGINE

Type...8-cylinder, 90° V, Overhead Valve
 Fuel.....Premium
 Displacement.....429 Cubic Inches
 Firing Order.....1, 5, 4, 2, 6, 3, 7, 8
 Bore.....4.36 Inches
 Stroke.....3.59 Inches
 Brake Horsepower.....375
 Torque.....410 @ 3400
 Oil Sump.....Aluminum
 Cylinder Block.....Cast Iron
 Cylinder Heads.....Aluminum
 Intake Manifold.....Aluminum
 Crankshaft....Forged Steel, Statically and Dynamically Balanced

Bearings.....Five
 Main Bearings Diameter.....2.9998
 Rod Bearings Diameter.....2.5000
 Valve Operation..Push Rod and Hydraulic Tappets

Inlet Valve Diameter.....2.285 to 2.275
 Exhaust Valve Diameter.....1.905 to 1.895
 Carburetor.....Holley, 4-Barrel, 735 CFM

CLUTCH

Ford High-Performance 11" Single Disc, External Spring Design

GEAR BOX

Ford, Fully-Synchronized Close-Ratio Four-Speed, 4.25" Center Distance With 31-Spline Heavy-Duty Output Shaft
 Ratios..2.32:1 First • 1.69:1 Second • 1.29:1 Third • Direct Fourth • 2.32:1 Reverse

REAR AXLE

Type...Hypoid, Straddle-Mounted Pinion With "Traction-Lok" Differential, Heavy-Duty 9" Ring Gear and 31-Spline Shaft
 Ratio (std.).....3.91:1
 Ratio (optional).....3.50 or 4.30:1

SUSPENSION

Competition-type suspension with ultra-heavy-duty front coil and rear leaf springs and shock absorbers, extra-heavy-duty front and rear stabilizer bars and a staggered rear shock absorber arrangement which directly restrains and damps out pitching motions of the axle housing during full-throttle starts. Rear stabilizer bar reduces roll on tight turns and reduces wheel hop on hard acceleration.

BRAKES

Type.....Power Assist Floating Caliper Front Disc with Heavy-Duty Hydraulic Rear Drums and High-Performance Low-Fade Lining
 Front Disc Diameter.....11.3 Inches
 Rear.....10 x 2 Inches

TIRES

F60 x 15 Super-Wide-Oval, Bias Cord with Fiberglass Belts Around Outer Periphery and Raised White Brand Letters

WHEELS

Stamped Steel "Magnum 500" Spider, 15" x 7", Attached to a Wide-Base Drop-Center Full Safety Steel Rim. Finish is chrome.

MUSTANG



Ford Division, Ford Motor Company